

SPACECRAFT COMPONENTS CORP.

Your Connector Consultant Since 1962

REVERSE BAYONET COUPLING CONNECTORS

DUST CAPS

& DUMMY RECEPTACLES

SCPB*TV/DCP19

SCPB*TF/DCR19

SCPB05/DRP19



▶ Special Platings Available

▶ Extensive Inventory



SPACECRAFT
COMPONENTS CORP.

DUST CAPS & DUMMY RECEPTACLES - REVERSE BAYONET

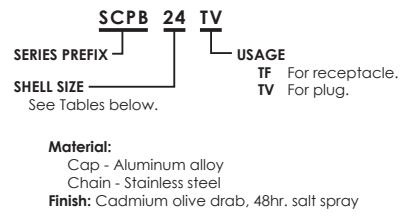
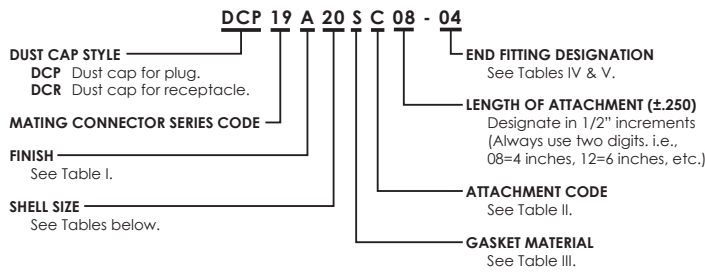

Dust Cap for Plug

SCPB*TV DCP19

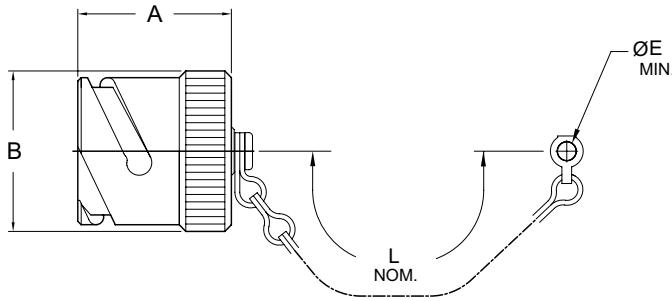

FOR PLUGS SCPB 06, 08, 064, 065

SHELL SIZE	A MAX.	B MAX.	E +0.5 -0.25	L APPROX.
10SL	1.142 [29.0]	.827 [21.0]	.173 [4.4]	4.252 [108]
12S	1.142 [29.0]	.930 [23.6]	.173 [4.4]	4.252 [108]
14S	1.142 [29.0]	1.083 [27.5]	.173 [4.4]	4.843 [123]
16S	1.142 [29.0]	1.181 [30.0]	.173 [4.4]	4.843 [123]
16	1.457 [37.0]	1.181 [30.0]	.173 [4.4]	4.843 [123]
18	1.457 [37.0]	1.319 [33.5]	.173 [4.4]	4.843 [123]
20	1.457 [37.0]	1.457 [37.0]	.189 [4.8]	5.433 [138]
22	1.457 [37.0]	1.575 [40.0]	.189 [4.8]	5.433 [138]
24	1.457 [37.0]	1.713 [43.5]	.189 [4.8]	5.433 [138]
28	1.457 [37.0]	1.949 [49.5]	.189 [4.8]	8.110 [206]
32	1.457 [37.0]	2.205 [56.0]	.220 [5.6]	8.110 [206]
36	1.457 [37.0]	2.461 [62.5]	.220 [5.6]	8.110 [206]
40	1.457 [37.0]	2.665 [67.7]	.220 [5.6]	8.110 [206]

1. Dimensions in brackets [] are in millimeters.

Dust Cap for Receptacle

SCPB*TF DCR19

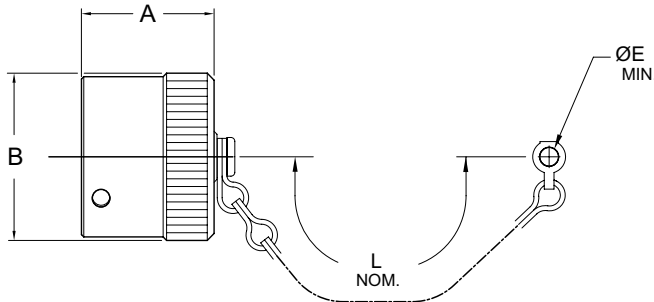

FOR RECEPTACLES

SCPB 00, 01 02, 03, 020, 030, 038, 07, 070, TB

SHELL SIZE	A MAX.	B MAX.	E +0.5 -0.25	L APPROX.
10SL	.787 [20.0]	.925 [23.5]	.173 [4.4]	4.252 [108]
12S	.787 [20.0]	1.030 [26.2]	.173 [4.4]	4.252 [108]
14S	.787 [20.0]	1.201 [30.5]	.173 [4.4]	4.252 [108]
16S	.787 [20.0]	1.299 [33.0]	.173 [4.4]	4.252 [108]
16	.984 [25.0]	1.299 [33.0]	.173 [4.4]	4.843 [123]
18	.984 [25.0]	1.476 [37.5]	.173 [4.4]	4.843 [123]
20	.984 [25.0]	1.614 [41.0]	.173 [4.4]	4.843 [123]
22	.984 [25.0]	1.732 [44.0]	.173 [4.4]	4.843 [123]
24	.984 [25.0]	1.870 [47.5]	.173 [4.4]	4.843 [123]
28	.984 [25.0]	2.146 [54.5]	.220 [5.6]	8.110 [206]
32	.984 [25.0]	2.402 [61.0]	.220 [5.6]	8.110 [206]
36	.984 [25.0]	2.657 [67.5]	.220 [5.6]	8.110 [206]
40	.984 [25.0]	2.874 [73.0]	.220 [5.6]	8.110 [206]

1. Dimensions in brackets [] are in millimeters.

Dummy Receptacle

SCPB05 DRP19

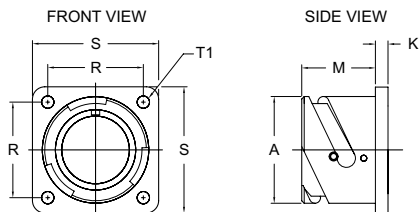
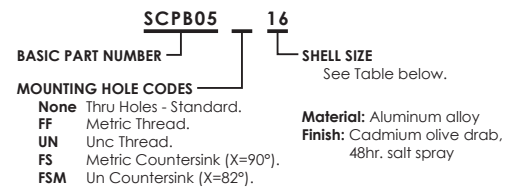
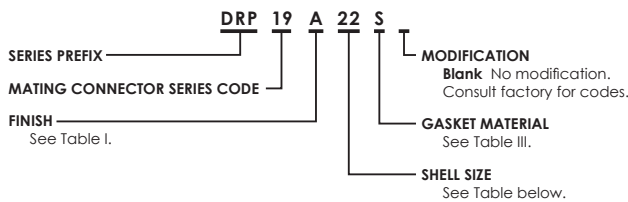

ENVIRONMENTAL WHEN USED WITH A FLANGE SEALING GASKET SCP36675 OR SCP4050

MOUNTING HOLE OPTIONS

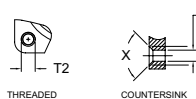

SHELL SIZE	FRONT VIEW					SIDE VIEW		
	R ±0.1	S ±0.3	T1 +0.1 -0.0	T2 THREAD		A +0.00 -0.15	K ±0.2	M +0.4 -0.0
				METRIC	UNC			
10SL	.717 [18.2]	1.000 [25.4]	.126 [3.2]	M4	8-32UNC	.717 [18.2]	.110 [2.8]	.559 [14.2]
12S	.809 [20.6]	1.125 [28.6]	.126 [3.2]	M4	8-32UNC	.836 [21.2]	.110 [2.8]	.559 [14.2]
14S	.906 [23.0]	1.181 [30.0]	.126 [3.2]	M4	8-32UNC	.969 [24.6]	.126 [3.2]	.559 [14.2]
16S	.969 [24.6]	1.280 [32.5]	.126 [3.2]	M4	8-32UNC	1.079 [27.4]	.126 [3.2]	.559 [14.2]
16	.969 [24.6]	1.280 [32.5]	.126 [3.2]	M4	8-32UNC	1.079 [27.4]	.126 [3.2]	.748 [19.0]
18	1.063 [27.0]	1.378 [35.0]	.126 [3.2]	M4	8-32UNC	1.213 [30.8]	.157 [4.0]	.748 [19.0]
20	1.157 [29.4]	1.496 [38.0]	.126 [3.2]	M4	8-32UNC	1.346 [34.2]	.157 [4.0]	.748 [19.0]
22	1.252 [31.8]	1.614 [41.0]	.126 [3.2]	M4	8-32UNC	1.472 [37.4]	.157 [4.0]	.748 [19.0]
24	1.374 [34.9]	1.752 [44.5]	.146 [3.7]	M4	10-24UNC	1.610 [40.9]	.157 [4.0]	.811 [20.6]
28	1.563 [39.7]	2.000 [50.8]	.146 [3.7]	M5	10-24UNC	1.839 [46.7]	.157 [4.0]	.811 [20.6]
32	1.752 [44.5]	2.244 [57.0]	.169 [4.3]	M5	1/4-20UNC	2.102 [53.4]	.157 [4.0]	.874 [22.2]
36	1.937 [49.2]	2.500 [63.5]	.169 [4.3]	M5	1/4-20UNC	2.346 [59.6]	.157 [4.0]	.874 [22.2]
40	2.185 [55.5]	2.748 [69.8]	.169 [4.3]	M5	1/4-20UNC	2.579 [65.5]	.157 [4.0]	.874 [22.2]

1. Dimensions in brackets [] are in millimeters.



**SPACECRAFT
COMPONENTS CORP.**

3040 Clayton Street
North Las Vegas, NV 89032

Phone: 702.851.7600
Fax: 702.851.7620

Email: salesinfo@spacecraft.com
Web: www.spacecraft.com

REVERSE BAYONET - DUST CAPS & DUMMY RECEPTACLES

SPACECRAFT CODES FOR: } DUST CAP FOR PLUG: **DCP19**
 DUST CAP FOR RECEPTACLE: **DCR19**
 DUMMY RECEPTACLE: **DRP19**

TABLE I. FINISH CODES
 CONSULT FACTORY FOR OTHER AVAILABLE FINISHES

Spacecraft Code	Finish	Specification(s)
H	● Anodize, Black	AMS-A-8625, Type II, Class 2
B	● Cadmium Plate, Black	AMS-QQ-P-416, Type II, Class 3
X	● Cadmium Plate, Bright Over Electroless Nickel	AMS-QQ-P-416, Type I, Class 3 ASTMB 733-90, SC2, Type I, Class 5 over AMS-C-26074, Class 4, Grade B
E	● Cadmium Plate, Gold Iridite, Over Electroless Nickel	MIL-C-5541, Class 3 AMS-QQ-P-416, Type II, Class 3 over AMS-C-26074, Class 4, Grade B
C	● Cadmium Plate, Olive Drab	AMS-QQ-P-416, Type II, Class 3, 48 Hours
A	● Cadmium Plate, Olive Drab Over Electroless Nickel	1000 Hour Corrosion Resistance
N	● Electroless Nickel	AMS-C-26074, Class 4, Grade B
L	● Zinc Cobalt, Dark Olive Drab	96 Hour Corrosion Resistance
P	● Passivated, Stainless Steel	AMS-QQ-P-35
T	● Nickel, Fluorocarbon Polymer	500 Hour Corrosion Resistance
W	● Zinc Nickel, Black	ASTM B841 Type D

TABLE II. ATTACHMENT CODES

Attachment Code	Description
A	No Attachment Required
B	Bead Chain, Brass, Nickel Plated
C	Sash Chain, SST, Passivated
D	Bead Chain, SST, Passivated
E	Bead Chain, Brass, Cadmium, Olive Drab Plated
F	Bead Chain, Brass, Unfinished
I	Bead Chain, Brass, Black Oxide Finish
N	Wire Rope, No Jacket
P	Wire Rope, Polyurethane Jacket with Terminal
R	Wire Rope, SST, PVC Covered, Green Color
T	Wire Rope, SST, Teflon Covered, Natural Cover
U	Wire Rope, SST, Nylon Covered, Brown Color
V	Wire Rope, SST, Viton Covered, Black Color
W	Nylon Cord, Green Color, SST Terminal

TABLE III. GASKET MATERIAL CODES

Material Code	Material Description
A	Fluorosilicone, Blue
N	Neoprene, Black, MIL-R-3065
O	None Required
S	Silicone, Red, ZZ-R-765
C	Conductive Silicone

TABLE IV. EYELET END FITTING STYLES AND SIZES
 (NOT USED WITH ATTACHMENT CODE A)

Dash No. Code	Y Ref. Dia.
00	No Eyelet
01	.125
02	.141
03	.167
04	.188
05	.219
06	.250
07	.156
08	.121

USED WITH ATTACHMENT CODES:

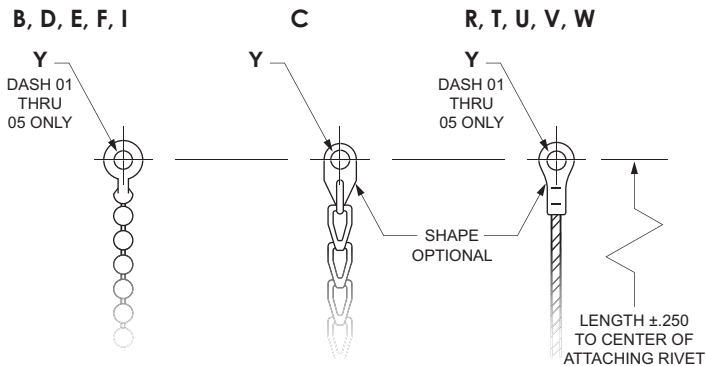
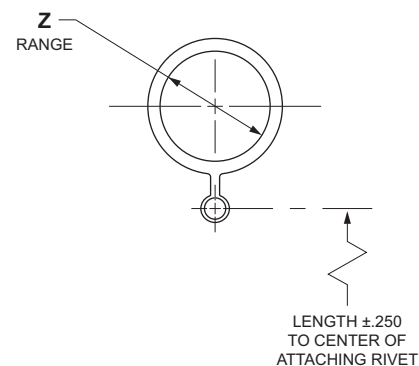

TABLE V. RING END FITTING SIZES
 (NOT USED WITH ATTACHMENT CODE A)

DASH NO. CODE	Z RANGE	DASH NO. CODE	Z RANGE	DASH NO. CODE	Z RANGE
33	.401 - .391	15	1.072 - 1.052	24	2.088 - 2.078
34	.454 - .444	16	1.198 - 1.178	25	2.151 - 2.141
35	.464 - .454	17	1.322 - 1.302	26	2.276 - 2.266
36	.526 - .516	18	1.448 - 1.428	27	2.338 - 2.328
11	.604 - .584	19	1.572 - 1.552	28	2.401 - 2.391
37	.651 - .641	20	1.698 - 1.678	29	2.526 - 2.516
12	.729 - .709	21	1.822 - 1.802	30	2.651 - 2.641
13	.885 - .865	22	1.948 - 1.928	31	2.901 - 2.891
14	.948 - .918	23	2.026 - 2.016	32	3.026 - 3.016

USED WITH ATTACHMENT CODES:
 B THRU W



SPACECRAFT COMPONENTS CORP.

Your Connector Consultant Since 1962

Try Our Other Connector Products



SCP 5015 STYLE CONNECTORS (CATALOG 102)



SCPT 26482 STYLE SC1 38999 SERIES I SC2 38999 SERIES II SC39 38999 SERIES III (CATALOG 202)



SCPB SERIES (CATALOG 302)



CONNECTOR ACCESSORIES (CATALOG 402)



CONNECTORS WITH INTEGRATED BACKSHELLS (CATALOG 601)



Get All of Our Catalogs & Product Brochures on One Disc



SPACECRAFT COMPONENTS CORP.



Headquarters

3040 Clayton Street
North Las Vegas, NV 89032

Phone: 702.851.7600
Fax: 702.851.7620

Email: salesinfo@spacecraft.com
Web: www.spacecraft.com

Florida Office

4577 Nob Hill Road
Suite 106
Sunrise, FL 33351
Tel: 954.748.4540
Fax: 954.748.4128

Arizona Office

519 W. Lone Cactus Dr.
Suite 401
Phoenix, AZ 85027
Tel: 623.580.1162
Fax: 623.580.1165

Italy Office

Spacecraft Components, sp A
Milan, Italy
+39 [335] 719.4512

Mexico Office

Av. Constituyentes 13-6 Col. Pueblo Nuevo
Queretaro, Qro 76900
+52 442 341 69 63

COMING SOON...
All Plastic Connectors
CATALOG 701

APR.2013
SF-149

COMPILED AND PRODUCED BY SPACECRAFT COMPONENTS CORP.
©2012 SPACECRAFT COMPONENTS CORP., NORTH LAS VEGAS, NV 89032